



**LC125 Meatwell
with
LDU15 Controller (Feb
'04 till July '09)
then
AT1-5 Controller (July
'09 onwards)**



Service Manual



ISO 14001



ISO 9001



Re-Issued October 2010
Original Aug 09

Contents









Manual Information & Health & Safety Notes	1
Environmental Management Policy	2
Disposal Requirements	2
Important Controller Change Information	3
Description, Maintenance & Technical Information	3
AT1-5 Controller Information	3 to 4
Alarms and Warnings	4 to 5
Probe Setting, Parameters & Adjustments	5 to 6
AT1-5 Wiring Diagram	7
LDU15 Controller Information	8
Parameters & Electrical Connections	9
LDU15 Wiring Diagram	10
Troubleshooting & Notes	11 to 13

Service Manual Information

The products and all information in this manual are subject to change without prior notice. We assume by the information given that the person(s) working on these refrigeration units are fully trained and skilled in all aspects of their workings. Also that they will use the appropriate safety equipment and take or meet precautions where required.

The service manual does not cover information on every variation of this unit; neither does it cover the installation or every possible operating or maintenance instruction for the units.

Health & Safety Warnings and Information

	Make sure the power supply is turned off before making any electrical repairs.
	To minimise shock and fire hazards, please do not plug or unplug the unit with wet hands.
	During maintenance and cleaning, please unplug the unit where required.
	Care must be taken when handling or working on the unit as sharp edges may cause personal injury, we recommend the wearing of suitable PPE.
	Ensure the correct moving and lifting procedures are used when relocating a unit.
	Do NOT use abrasive cleaning products, only those that are recommended. Never scour any parts of the refrigerator. Scouring pads or chemicals may cause damage by scratching or dulling polished surface finishes.
	Failure to keep the condenser clean may cause premature failure of the motor/compressor which will NOT be covered under warranty policy.
	Do NOT touch the cold surfaces in the freezer compartment. Particularly when hands are damp or wet, skin may adhere to these extremely cold surfaces and cause frostbite.
	Please ensure the appropriate use of safety aids or Personnel Protective Equipment (PPE) are used for you own safety.

Environmental Management Policy for Service Manuals and Duets.

Product Support and Installation Contractors

Foster Refrigerator recognises that its activities, products and services can have an adverse impact upon the environment.

The organisation is committed to implementing systems and controls to manage, reduce and eliminate its adverse environmental impacts wherever possible, and has formulated an Environmental Policy outlining our core aims. A copy of the Environmental Policy is available to all contractors and suppliers upon request.

The organisation is committed to working with suppliers and contractors where their activities have the potential to impact upon the environment. To achieve the aims stated in the Environmental Policy we require that all suppliers and contractors operate in compliance with the law and are committed to best practice in environmental management.

Product Support and Installation contractors are required to:

1. Ensure that wherever possible waste is removed from the client's site, where arrangements are in place all waste should be returned to Foster Refrigerator's premises. In certain circumstances waste may be disposed of on the client's site; if permission is given, if the client has arrangements in place for the type of waste.
2. If arranging for the disposal of your waste, handle, store and dispose of it in such a way as to prevent its escape into the environment, harm to human health, and to ensure the compliance with the environmental law. Guidance is available from the Environment Agency on how to comply with the waste management 'duty of care'.
3. The following waste must be stored of separately from other wastes, as they are hazardous to the environment: refrigerants, polyurethane foam, and oils.
4. When arranging for disposal of waste, ensure a waste transfer note or consignment note is completed as appropriate. Ensure that all waste is correctly described on the waste note and include the appropriate six-digit code from the European Waste Catalogue. Your waste contractor or Foster can provide further information if necessary.
5. Ensure that all waste is removed by a registered waste carrier, a carrier in possession of a waste management licence, or a carrier holding an appropriate exemption. Ensure the person receiving the waste at its ultimate destination is in receipt of a waste management licence or valid exemption.
6. Handle and store refrigerants in such a way as to prevent their emission to atmosphere, and ensure they are disposed of safely and in accordance with environmental law.
7. Make arrangements to ensure all staff who handle refrigerants do so at a level of competence consistent with the City Guilds 2078 Handling Refrigerants qualification or equivalent qualification.
8. Ensure all liquid substances are securely stored to prevent leaks and spill, and are **not** disposed of to storm drains, foul drain, or surface water to soil.

Disposal Requirements

If not disposed of properly all refrigerators have components that can be harmful to the environment. All old refrigerators must be disposed of by appropriately registered and licensed waste contractors, and in accordance with national laws and regulations.

IMPORTANT CONTROLLER CHANGE INFORMATION

**AS OF FEB 2004 THIS UNIT HAD THE LDU15 (00-555357) CONTROLLER.
AS OF 22ND JULY 2009 THIS HAS NOW BEEN REPLACED WITH AN AT1-5 (00-556223) CONTROLLER.
PLEASE NOTE THAT IF YOU ARE REPLACING THE LDU15 CONTROLLER TO THE NEW AT1-5
CONTROLLER YOU WILL ALSO HAVE TO REPLACE THE AIR PROBE WITH SN4K150P1 (00-556187).**

This manual provides information on both controllers.

Meatwell Description

This is a one piece foam shell with a skin evaporator and bottom mount condensing system. The condensing system uses R134a refrigerant. The cabinet is designed for the storage of frozen products and is top loading. It is fitted with four 60mm castors, rubber bumpers to each corner and a front smash bar is available as an added option (but fitted as standard to Burger King units).

Routine Maintenance

In order to keep the unit operating reliably and efficiently periodical cleaning of the condenser is necessary. (The frequency being determined by site conditions)

This operation is to be carried out with the unit turned OFF.

We advise the use of a soft long haired brush on the outside of the condenser taking care not to damage the fins.

Warning: Condenser fins have sharp edges so care must be taken to avoid injury

Technical Information

Temperature Set Point	-21°C
Refrigerant	R134A
Refrigerant Charge	180grms
Capillary	4.4mts x 042
Power Supply	230/50/1

Controller Information for models using the LAE AT1-5BS6E-FS1 Controller (00-556223)



Operation Guidelines –

Please note the unit has a rest time of 10mins before start up will begin.

Initial Start Up

Start Up & self Test: 

The indication is only displayed during the first three seconds following the mains electrical power being applied to the unit. During this period the controller performs a self-check.

Once the self-check has been completed  will be displayed.

Press and hold  for three seconds. The unit will start and the air temperature will be displayed.
Check temperature set point.

To make adjustments to the set point it is necessary to access the parameter and alter SPL and SPH accordingly.



Check set point by pressing the  button

To increase set point press  +  until required temperature is displayed.

To decrease set point press  +  until required temperature is displayed.
Exit from set up occurs after 10 seconds if no button is pressed.



Manual Defrost

To initiate a manual defrost press and hold .

 will be displayed release .

On completion of the defrost  will be displayed until the cabinet temperature is achieved and then it will revert to displaying the normal cabinet temperature.

Set Unit to Standby

Press , in the display  will show

This indication is displayed while the unit is not operating but with mains power applied to the unit. This mode may be used for internal cleaning regimes and short periods when the unit is not required.
For extended periods of inactivity the mains supply should be isolated.

Alarm and Warnings

High Temperature Alarm

 Will be displayed.

The alarm will sound but can be silenced by pressing any of the buttons, however it will return after the pre-set designated period. The unit will return to normal operating temperature and will automatically cancel the alarm.
Possible Causes: The evaporator fan is not working; there is a restricted airflow through the air duct. The evaporator is iced up or the compressor is not working.

Low Temperature Alarm.

 Will be displayed.

The alarm will sound but can be silenced by pressing any of the buttons, however it will return after the pre-set designated period. The unit will return to normal operating temperature and will automatically cancel the alarm.
Possible Causes: Controller is faulty (not switching compressor off). The compressors secondary relay will not de-energise (low temperature models).

Air Temperature Probe Failure

 Will be displayed.

The alarm will sound but can be silenced by pressing any button.
There is no further action that can be taken by the user in this instance. During this period the unit will continue to operate but have a reduced performance.
Action: Replace Probe.

Information Menu

Pressing and releasing  activates the information menu. From this menu you can display the temperature relating to T1 (air probe), T2 (evaporator probe, if fitted) and T3 (condenser probe, if fitted).
The maximum temperature (THI) and the minimum temperature (TLO) the cabinet has achieved since it was last re-set.
The total operating time of the condenser (CND) since it was last cleaned, and the keyboard status (LOC).

The information to be displayed can be selected sequentially by pressing  repeatedly or scrolling

through the menu using the  or  buttons.

Once selected press  to display the value.

Exit from the info menu by pressing  or it will automatically exit after 6 seconds if no buttons are pressed.

To reset the temperature settings recorded in THI and TLO and the hours counted in CND, access the info menu

press  to display the value plus  simultaneously for resetting to be completed.

To check the LOC status scroll through to LOC, press  to display status – YES to lock keys. – NO to leave keys accessible.

NOTE: with the keys locked it is not possible to turn the unit OFF or ON or to check the set point.

Parameter Setting and Adjustment

It is strongly advised that before adjusting any Service Parameters a thorough understanding of the following instructions should be obtained.

The parameters are accessed by pressing the following keys in succession  +  and keeping them pressed for 5 seconds.

After this period the first parameter 'SCL' will be displayed.

Press  button to pass from one parameter to the next and  button to go back.

Press  to display the value followed by  or  to change it.

Exit from set up is by pressing  or automatic if no buttons are pressed for 30 seconds.

Probe Identification

The probe fitted to this controller is the 10k NTC type (LAE SN4K15P1, Part number 00-556187) with red letter identification.

LAE NTC10K Temperature Resistance Table

Temperature(°C)	R-mid (KΩ)	Temperature(°C)	R-mid (KΩ)	Temperature(°C)	R-mid (KΩ)
-25	87.559	-5	33.892	15	14.674
-20	68.237	0	27.219	20	12.081
-15	53.65	5	21.63	25	10
-10	42.506	10	17.926	30	8.315

LAE AT1-5BS6E-FS1 Controller Parameter List

Mnem.	Definition	Min	Max	Default	Dim	Setting
SCL	Readout Scale	1°C ; 2 °C ; F °		2	flag	2 °C
SPL	Minimum Set Point (1)	-50	SPH	-5	°C	-21
SPH	Maximum Set Point (1)	SPL	120	5	°C	-21
SP	Set Point (1)	SPL	SPH	0	°C	-21
C-H	Refrigeration / Heating	REF	HEA	REF	flag	REF
HYS	Thermostat Hysteresis	1	100	3	°K	3
CRT	Minimum Compressor Rest Time	0	30	3	min	10
CT1	Compressor Run with T1 Failure	0	30	3	min	7
CT2	Compressor Stop With T1 Failure	0	30	6	min	3
CSD	Compressor Stop Delay From Door Opening	0	30	1	min	1
DFR	Defrost Frequency / 24h	0	24	3	1/24	0
DLI	Defrost End Temperature	-30	30	6	°C	15
DTO	Maximum Defrost Duration	1	120	20	min	20
DTY	Defrost Type	OFF; ELE; GAS		ELE	Flag	OFF
DDY	Defrost Display Control	0	60	10	Min	20
ATM	Alarm Threshold Control	NON; ABS; REL		ABS	flag	REL
ALA('R)	Low Temperature Alarm Threshold	-50 (-120)	+120 (0)	-50	°C/ °K	-25
AHA('R)	High Temperature Alarm Threshold	-50 (0)	+120 (120)	120	°C/ °K	-10
ALR	Low Temperature Alarm Differential	-12	0		°K	-5
AHR	High Temperature Alarm Differential	0	12		°K	5
ATD	Alarm Temperature Delay	0	120	30	min	90
ADO	Door Alarm Delay	0	30	5	min	5
ACC	Condenser Cleaning Period	0	52	0	wks	0
SB	Button 0/1 Enabling	YES	NO	YES	flag	YES
DS	Door Switch Enabling	YES	NO	NO	flag	NO
OAU	AUX Output Control	NON;0-1;LGT;FAN;AL1		LGT	flag	NON
INP	SN4 / ST1	SN4; ST1		SN4	flag	SN4
OS1	T1 (air) Probe Offset	-125	125	0	°K	0
T2	T2 (evaporator) Probe Enabling	YES	NO	NO	flag	NO
OS2	T2 (evaporator) Probe Offset	-125	125	0	°K	0
TLD	Delay for Minimum / Maximum Temperature Storage	1	30	5	min	5
SIM	Display Slowdown	0	100	0	exp	50
ADR	Unit Peripheral Address	1	255	1	exp	1

LC125 Wiring Diagram with the LAE AT1-5BS6E-FS1 Controller

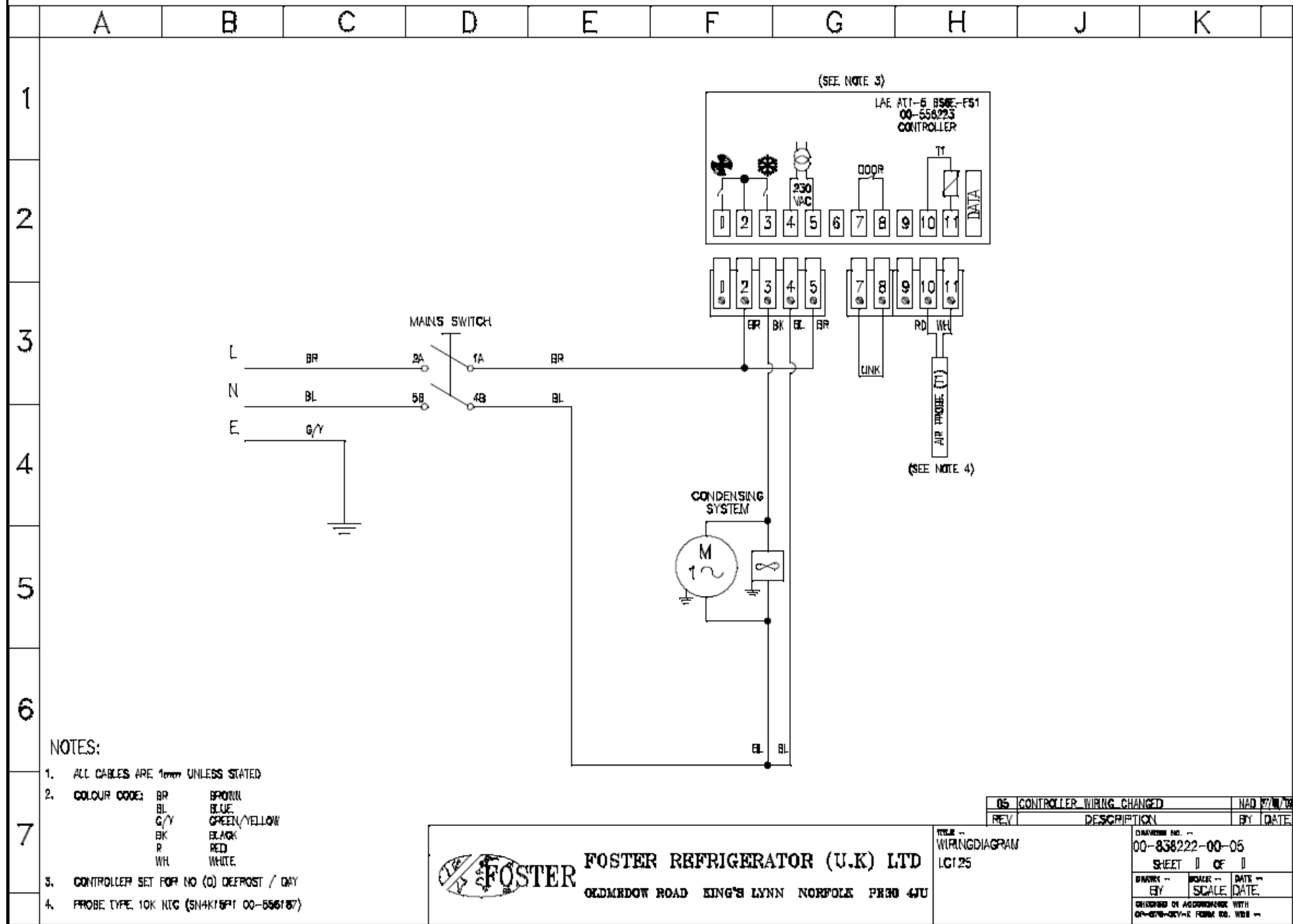

NOTES:

1. ALL CABLES ARE 1mm² UNLESS STATED
2. COLOUR CODE: BR BROWN, BL BLUE, G/Y GREEN/YELLOW, BK BLACK, R RED, WH WHITE.
3. CONTROLLER SET FOR NO (D) DEFROST / DAY
4. PROBE TYPE 10K NTC (SH4K15P1 00-556187)

FOSTER FOSTER REFRIGERATOR (U.K.) LTD
 OLDMRDOW ROAD KING'S LYNN NORFOLK PR20 4JU

TITLE --
 WIRINGDIAGRAM
 LC125

05	CONTROLLER WIRING CHANGED	HAD P2/W/TB
REV	DESCRIPTION	BY DATE
DRAWING NO. -- 00-838222-00-05		
SHEET 1 OF 1		
DRAWN --	SCALE --	DATE --
BY	SCALE	DATE
CHECKED BY APPROVING WITH CR-070-021-K FORM NO. 108 --		

Controller Information for models using the LDU 151E-BG Controller (00-555357)

When the controller is switched on a single line appears on the display for 3 seconds to indicate the autotest period.
 After this period the air temperature measured by the T1 probe is displayed.

It is strongly advised that before adjusting any Service Parameters a thorough understanding of the following instructions should be obtained.

LDU 15 Controller

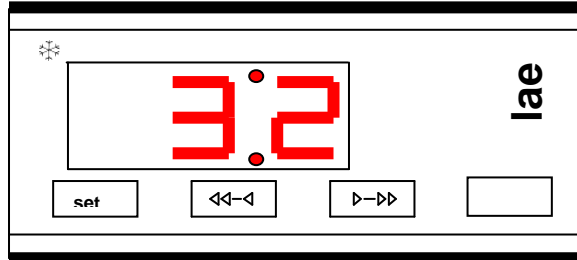

Check temperature set point.

Check set point by pressing the “set” button

To increase set point press “set” + 

To decrease set point press “set” + 



Factory Temperature Set Point -21°C.

Exit from set up occurs after 10 seconds if no button is pressed.



Manual Defrost.

To initiate a manual defrost press buttons  and  simultaneously.



Controller Set Up.

The parameters are accessed by pressing the following keys in succession  + “set” +  and keeping them pressed for 3 seconds.

Access to the parameters has been achieved with the first parameter SCL being displayed.

To pass from one parameter to the next press either the  or  key.

To display the value press. “set”

To change the value press “set” +  to increase, or “set” +  to decrease.

Exit from set up by pressing “aux” or is automatic after 30 seconds if no buttons are pressed.

Alarms and Warnings

HI	High Temperature Alarm
LO	Low Temperature Alarm
E1	T1 Probe Failure
DF	Defrosting in Progress
CLN	Condenser

Parameters for Cabinets with the LDU15 1E-B Controller

Display	Parameter	LDU151E-B Default Values	LC 125
SCL	Readout Scale	2°C	2°C
SPL	Minimum Temperature Set Point	05	-25
SPH	Maximum Temperature Set Point	01	-15
SP	Effective Temperature Set Point	03	-21
HYS	Hysteresis	3	+3
CRT	Compressor Rest Time (minutes)	10	0
CDC	Compressor Regulation with T1 Fail	20	7
DFR	Defrosting Frequency (/24 hours)	4	0
DTO	Defrosting Duration (minutes)	20	20
DDY	Defrost Display Control	1	1
ATL	Low Alarm Differential	-5	-10
ATH	High Alarm Differential	5	10
ATD	Temperature Alarm Delay (minutes)	60	90
ACC	Condenser Clean Interval	05	0
OAU	Auxiliary Output Mode of Operation	30	NON
BAU	Auxiliary Button Mode of Operation	05	NON
OS1	T1 Offset	00	00
SIM	Display Slowdown	00	00
ADR	Address	01	01



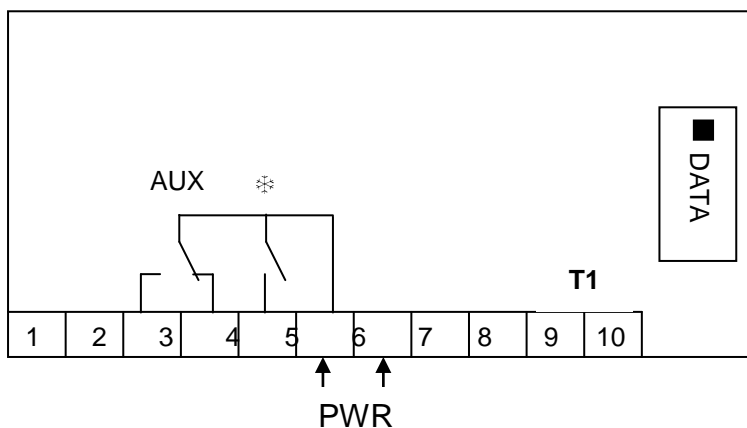



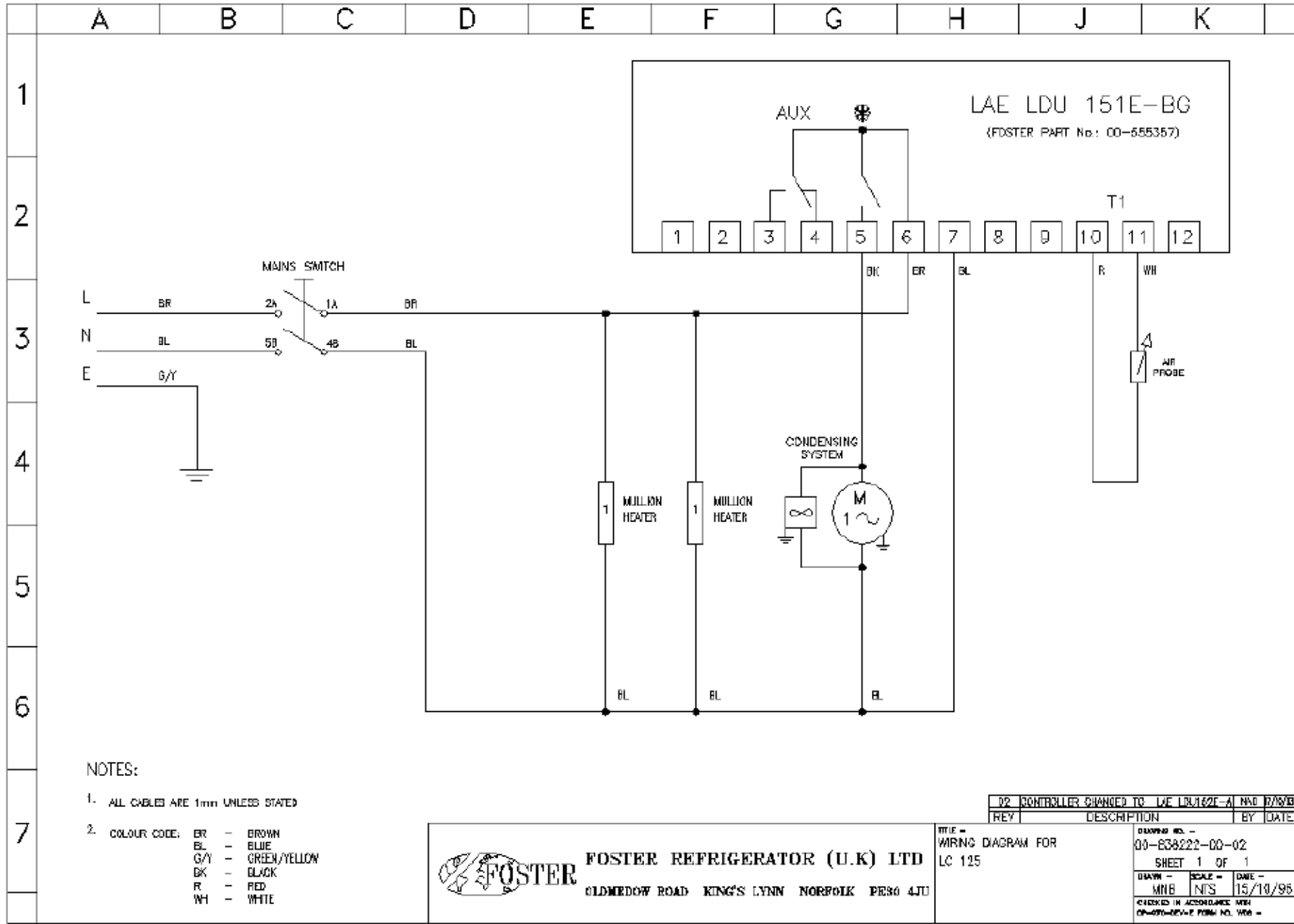



LDU 151E-BG Electrical Connections













Wiring Diagram for Models Using the LDU15 Controller



Troubleshooting

Problem	Possible Cause	Solution
Compressor will not start	No voltage in socket	Use voltmeter to check
	Electrical conductor or wires may be cut	Use ohmmeter to check for continuity
	Defective electrical component: thermostat, relay, thermal protector etc	Replace defective component
	Compressor motor has a winding open or shorted	Measure ohmic resistance of main and auxiliary winding using ohmmeter. Compare with correct values
	Compressor stuck	Change compressor
	Temperature control contacts are open	Repair or replace the contacts
	Incorrect wiring	Check wiring diagram and correct
	Fuse blown or circuit breaker tripped.	Replace fuse or reset circuit breaker
	Power cord unplugged	Plug in power cord.
	Controller set too high	Set controller to lower temperature.
	Cabinet in defrost cycle	Wait for defrost cycle to finish
The temperature is too cold	Controller is set at a very cold position	Set to warmer position and check if the compressor stops according to controllers operating range.
	Controller does not disconnect the condensing unit	Check the insulation of the thermostat. If problem persists, change the thermostat
	Control contacts are stuck closed	Change the control. Check amperage load
	Defective or incorrect temperature control	Determine correct control and replace.
The temperature is not cold enough	Controller is set at a very warm position	Adjust to colder setting
	Condenser is dirty	Clean condenser
	The refrigerator has been placed at an inadequate location	The unit must not be near stoves, walls that are exposed to the sun, or places that lack sufficient air flow.
	Compressor is inefficient or there is a high pressure due to the air in the system	If there is air in the system, purge and recharge
 	Iced up evaporator coil	Check temperature control, refrigerant charge, and defrost mechanism. Remove all ice manually and start over.
	Restriction in system	Locate exact point of restriction and correct
	The refrigerator has been used improperly	The shelves must never be covered with any type of plastic or other material that will block the circulation of cold air within the refrigerator.
	Too many door openings	Advise user to decrease if possible
	Excessive heat load placed in cabinet	Advise user not to put in products that are too hot.

	The refrigerator has been overcharged with the refrigerant gas	Check to see if condensation or ice crystals have formed on the suction line. If so, charge with the correct amount of gas.
	The refrigerant gas is leaking	Find the location of gas leak in order to seal and replace the defective component. Change the drier. Perform a good vacuum and recharge unit.
	The evaporator and/or condenser fans are not working	Check electrical connections and make sure that the fan blade isn't stuck. Replace the fan motor if it doesn't work.
	Blocking air flow	Re-arrange product to allow for proper air flow. Make sure there is at least four inches of clearance from evaporator.
	Fuse blown or circuit breaker tripped	Replace fuse or reset circuit breaker.
Electrical Shocks		
	Wires or electrical components are in direct contact with metallic parts.	Check for appropriate insulation on the connections of each component.
Noise		
	The refrigerator is not properly levelled	Check if the noise goes away after you level the refrigerator
	The condenser is not fastened correctly. Copper tubing is in contact with metal	While the compressor is working, check to see if metal parts are in contact with one another and/or if the screws that fasten the condenser are tightened.
	The evaporator and/or condenser fans are loose	Check if the fans are securely fastened. Also, check if the fan blades are loose, broken or crooked. If so, change the faulty blade.
	Compressor has an internal noise	If the noise persists after all other measures have been taken, it may be originating from the compressor.
	Loose part(s)	Locate and tighten loose part(s)
Extreme condensation inside the refrigerator	Controller is set at a very cold position	Set the controller to a warmer position & check to see if compressor stops as should.
	The outside environment's relative humidity is very high (over 75%)	This type of occurrence is caused by local climatic conditions and not by the refrigeration unit.
	The refrigerator door wont shut completely	Check the door and/or the magnetic gasket. Adjust the door hinges if needed; replace the gasket if broken.
	The refrigerator had been placed at an inadequate location	The unit must not be near sources that produce too much heat.
No illumination (Glass door models only)	The light switch is "off" position	Press the light switch to "on" position
	False contact on the light switch, the fluorescent tube, or the ballast	Inspect all connections
	Light switch, ballast and/or fluorescent tube are damaged	Replace the damaged component.

Condensing unit runs for long periods of time		Excessive amount of warm product placed in cabinet	Advise user to leave adequate time for products to cool down
		Prolonged door opening or door ajar	Advise user to ensure doors are closed when not in use and to avoid opening doors for long periods of time.
		Door gasket(s) not sealing properly	Ensure gaskets are snapped in completely. Remove gasket and wash with soap and water. Check condition of gasket & replace if necessary
		Dirty condenser coil	Clean condenser coil
		Evaporator coil iced over	Unplug unit and allow coil to defrost. Make sure thermostat is not set too cold. Ensure that door gasket(s) are sealing properly. Select manual defrost and ensure system works.

Notes



Foster European Operations

France

Foster Refrigerator France SA
Tel: (33) 01 34 30 22 22. Fax: (33) 01 30 37 68 74.
Email: commercial@fosterfrance.com

Germany

Foster Refrigerator Gmbh,
Tel: (49) 781 990 7840. Fax (49) 781 990 7844.
Email: info@foster-gmbh.de

Foster Refrigerator
Oldmedow Road
Kings Lynn
Norfolk
PE30 4JU

Tel: 0843 216 8833
Fax: 0843 216 4707
Website: www.fosterrefrigerator.co.uk
Email: support@foster-uk.com

a Division of 'ITW (UK) Ltd'

LCU15/LDU15 & ATI-5/SM 10/10